

COMPOSITE ENTRY DOORS

OFFER 2018/2019



WARM

DURABLE

SAFE

Brand - promise fulfilment guarantee.

VIKKING Composite Doors is a guarantee of the highest quality for generations

We have created from scratch innovative composite doors of the highest quality and durability.

Regardless of the statutory requirements of consumer protection in the form of warranty for faults and liability for non-conformity of the product with the agreement - we take the challenge of granting the extended warranty for trouble-free operation:

25 years	Composite sashes - lines ARCTIC PLUS and ARCTIC
20 years	Composite sashes - line PREMIUM
15 years	Composite sashes - line BASIC
10 years	PVC frames, hinges and locking plates
5 years	Paint coatings and stained glass units
3 years	Stripe locks and technical efficiency of other components



Clear rules

Ensuring the technical functioning is conditioned by:

- I - correct, adequate to operating conditions selection of doors lines and its equipment
- II - the use of composite door in accordance with its intended use
- III - the correct installation of the door by authorized installers with use of warm assembly according to the manufacturer's guidelines
- IV - making periodic checks, adjustments and maintenance according to the manufacturer's guidelines
- V - immediate removal of possible faults, that will protect against further damage of the door
- VI - the use the door in the segment of individual housing construction, for other applications, apply the standard 3-year warranty

The full content of the guarantee and guidance on quality acceptance, correct installation, operation and maintenance we attach to each product in the language of country of destination.

We provide warranty and post-warranty service.





New in 2018

- Doors XXL
- Changes in lines
ARCTIC PLUS and ARCTIC
- Collection with 3D application
- Illuminated sash
- RAL colors with pearl effect

Personalized solutions in joinery is our speciality.

You don't have to settle for compromises no more!

Not all suppliers are able to meet the stringent requirements for the highest aesthetic of doors combined with the best protection of your home.

We have developed from the scratch innovative composite doors to meet your most demanding expectations.

Advanced technology and innovative solutions enable to make any door of your dreams without any concessions in quality and durability!

No other doors have as many advantages, without defects and limitations associated with traditional technologies, composite doors are resistant to adverse weather conditions, don't absorb the moisture, don't corrode and retain consistently high quality for decades.

For years, our motto is:

"What for others is unusual - we treat it as a standard, what for others is impossible - we make it tomorrow".

For years, VIKKING is specializing in the implementation of most custom orders.

Unleash your creativity from the threshold and start by changing the door.

Choose your style, any combination of colours and surface textures of doors, choose most convenient handles and beautiful stained glass packets, we will take care of the rest with the greatest reverence.

To ensure the transparency of our extremely rich offer, this publication will make it easy to choose the door, this publication will make it easy to choose the most suitable door in terms of lines, collections, models and equipment.

Four product lines divided in to two collections, not limited by imagination, number of models and stained glass noble patterns, it is unquestionable advantage of VIKKING composite doors.



Be open for new possibilities!

PROTECTION OF YOUR HOME



- effectively protect against the heat loss - U_0 factor from **0,60 W/m²K**,
- doors from ARCTIC PLUS, ARCTIC i PREMIUM lines are standard equipped with multi-point anti-burglary strip locks,
- excellent resistance to vandalism and burglary - RC II class according to the standard (PN-EN 1627:2011),
- protects against the noise of the busy street,

TAILOR-MADE



- unlimited selection of models, sizes, colors and unique stained - glass decorations from own studio,
- a wide range of top quality fittings and door accessories,
- doors adapted to custom building openings,
- double doors and sidelights in various sizes and shapes,
- only in composite doors resistant to moisture PVC door frames with extensions system, connectors and sidelights in any configuration,
- on request frames from the highest quality meranti wood,
- rebate or non-rebated doors, opening to the inside or outside,

FUNCTIONAL



- maintenance of door kept to a minimum and is not complicated,
- paint coatings don't require periodic maintenance,
- composite doors have the optimal price - advantage ratio,
- each order is individually produced by experienced professionals, for whom customer satisfaction is the highest recognition,

SOLID

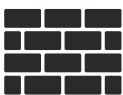

- composite doors have the aesthetics of wood, light weight of aluminium, resistance of steel and durability of PVC, are also free from defects associated to traditional materials,
- advanced technology, the highest quality components, fittings and coatings of renowned manufacturers provide many years of trouble-free operation,
- composite surface sashes are resistant to friction and scratches,,
- composite doors VIKKING are resistant to moisture and most difficult climatic conditions - composite sashes don't deform under the influence of the weather conditions, we can guarantee their constant technical durability for decades,

UNIQUE



- by using to production composite materials with unreachable for traditional materials parameters - we set new trends in the quality and design of the front door,
- Vikking composite doors are manufactured using advanced technologies that are protected by the international patents,
- innovative structural pasting of glass units, provides a stability of doors, safety and protection against loss of energy,
- composite doors with smooth surface, or in its unique combination,
- innovative stained glass in unlimited design, hand-created in own studio by the best craftsmen.

VIKKING composite doors - worth choosing.

Align doors to house not house to doors.

Elastic offer



Doors in **XXL size**

Max. height: 2450 mm
Max. width: 1150 mm



Custom made model

The possibility of using sidelights
and transom in any
configuration, sizes and shapes.

Check the variant configuration on page **32**.

NEW

Door with 3D sash

3D

Door with 3D sash – composite door sash 65 mm from the ARCTIC line and an additional one composite cover with a thickness of 43 mm.

The 3D sash is available in the following models, only in ARCTIC line in the door opening to inside.

Outside dimensions of doors from this collection:

- 970 x 2030
- 970 x 2130
- 1070 x 2030
- 1070 x 2130

STRONG ACCENT
FOUR MODELS WITH 3D SASH



Collection 3D

Available models in 3D collection



Diplomat 7M



Diplomat C5



Diplomat 6K



Diplomat C6



Diplomat B3



resin technology in glass packet or sidelight



painted inox flushed with door surface

Mark your house number permanently and aesthetically.

(send inquiry: wyceny@vikking.eu)



Fingerprint reader

PS handrail
available in sizes:
• 1800 mm
• 2000 mm
• 2200 mm

Light under the sash

Diplomat 3Z

NEW

Highlighted entrance

Only in the VIKKING offer, external doors with LED lighting mounted from below.

Available in all lines, models, in doors opening in and out.

To choose:

- warm light
- cold light

Subtle effect of delicate glow

Welcome your guests with a unique entrance

Beautiful entrance counts



RealWood surface

Composite sash surface that perfectly reflects wood grain



Smooth surface - RealWood surface

Possibility to combine with RealWood surface on the same door. Varnished in two or more colours.



Milled decorations

Possibility to create any pattern of a client idea.



INOX decorative elements

Frames and borders made of stainless steel fully flushed with sash or mounted on top.



STONE application

Collection decorated with natural stone, partly flushed with sash.



Composite advantage

Frames in color of sash or any other



Perpetual coloristics

Full pallet of RAL colours, metallic and fluorescent colours and ten woodgrain decorations.

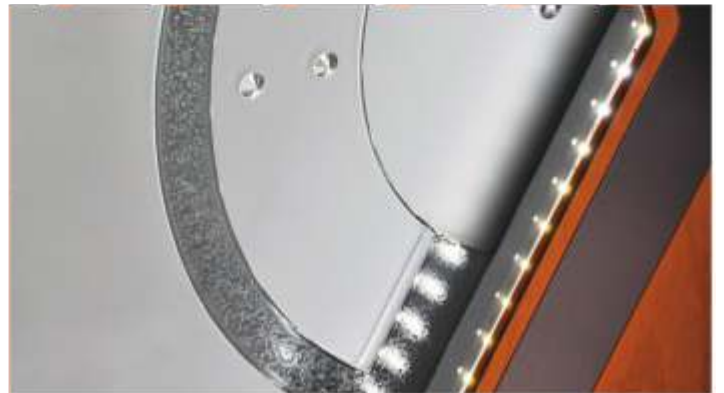

LED light

Mounted in glazing units and sidelights.

Colors from RAL palette with PEARL effect

NEW



















Colors with pearl effect

VIKKING composite doors are painted with highest quality lacquers. We are able to paint our doors and windows in any colour from RAL palette with **PEARL effect**.



INFORMATION SYSTEM ■ VARIANTS OF DECORATIONS AND APPLICATIONS

- | | |
|--|--|
|  RAL colours |  PL Inox strip on top |
|  Woodgrain colours |  LC Inox plinth (on top, height 90 mm) |
|  SMOOTH Smooth door surface |  KW Interior composite frame |
|  RW Real Wood surface (structure of precious wood) |  ZW Both sided frameless system |
|  STONE STONE application - onesided |  RR Decorative door frame from classic collection |
|  3D 3D application |  RZ Flushed Inox frame |
|  F Milled sash surface decors - onesided |  RN Inox frame on top |
|  FL IFlushed Inox strip |  KZ External composite frame |

Perpetual application possibilities, perfectly highlights aesthetic door qualities and give them individual character. You choose how your doors will look at the end.

- 1** Innovative, six-chamber PVC door frame class A Plus with smooth surface or RealWood. PVC profiles are resistant to moisture, perfectly insulate from the cold and require no maintenance. Extension system, connectors and clamps provide any configuration and frames equipment.
- 2** Composite sash with specially reinforced construction which prevents deformation, even in difficult weather conditions; resistant to moisture and mechanical damage. Only composite sashes keep consistently high quality for decades without the need of maintenance and painting.
- 3** Solid multi-layer construction provides stability of the sash and burglar protection. Sash linings made from the highest quality composite panels resistant to scratches and damage.
- 4** Waterproof composite frame protects the interior of the sash from moisture and freon-free insulation provides excellent protection against the heat loss.
- 5** The highest quality coatings in any RAL colours or in one of the many wood grain decorations combined with total resistance of composite doors to moisture makes them resistant in the extent of the reach of traditional materials.
- 6** Silicone seals designed specially for composite doors, provide maximum protection against heat loss around the perimeter and provide a pleasant sound when closing.
- 7** Low threshold's system with durable aluminium thermal barrier and thermal subliminal insulation profiles, provides comfort through excellent insulation and stable foundation door. The threshold height is only 20mm.
- 8** Heat-insulated threshold profiles with warm assembly system provide a stable positioning of door eliminates thermal bridges and protects against moisture and system of multi-point locks and anti-theft blockades raises the level of burglary protection.



Low threshold
only 20 mm
for your convenience

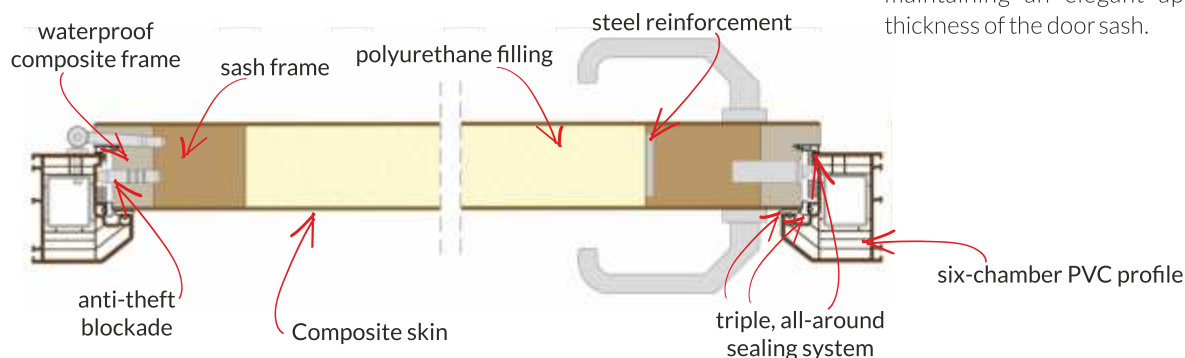

Burglary resistance RCII

ACCORDING TO THE STANDARD (PN-EN 1627:2011)

Because of design and top quality fittings - composite doors have excellent resistance to burglary, vandalism and mechanical damage.

U_p factor from 0,63 W/m²K

PASSIVE STANDARD

Why U_p factor is so important?

U_p - Coefficient of thermal insulation

The low value of this ratio ensures heat loss reduction in house and little power for energy to heating the house.

In Viking composite doors because of connection materials and components with perfect parameters we have the lowest coefficient of thermal insulation while maintaining an elegant appearance and optimum thickness of the door sash.

Static connector

with steel reinforcement provide construction stability allowing usage of large dimension sidelights and top transoms lights.

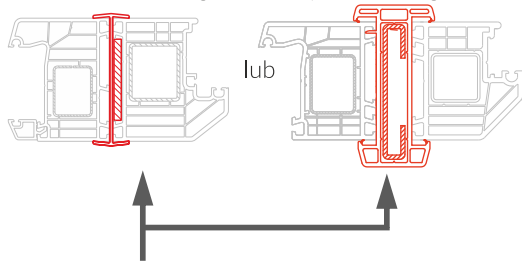

Multipoint locking system



Smart control



3D hinges

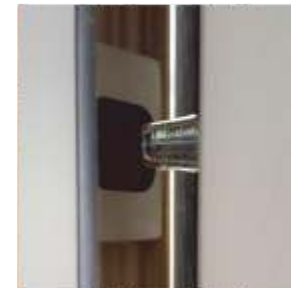

Anti-theft blockades



Triple-glass packets with Super Spacer bar



Silicone seals

















Low aluminum threshold with thermal barrier and subthreshold profile



Wind-stop seal

INFORMATION SYSTEM ■ TECHNICAL PARAMETERS

-  Guarantee of the technical efficiency of the composite sash
-  Product meets the requirements of the European Union
-  Coefficient of thermal insulation barrier UD=X,XX W/m²K
-  Anti-burglar according to PN-EN 1627:2011
-  Soundproofing
-  The requirement of a full roofing
-  Sash thickness

-  Rebate system
-  Triple sealing system
-  Triple glazing units
-  Super Spacer warm edge between the glass
-  Handle locked strip locking system
-  Key-locked strip locking system
-  Key-locked automatic strip locking system

We constantly develop and improve production processes, so that you can decide on the final design and accessories of door of your dreams.

ARCTIC PLUS

DEDICATED FOR PASSIVE BUILDINGS AND ZERO ENERGY HOUSES

External entry doors opened inward or outward

Composite doors of ARCTIC PLUS line - the quintessence of timeless design, excellent quality and legendary resistance to climatic conditions. These doors set new standards of energy losses reduction and conservancy of natural resources.

Do not require roofs!

You no longer need to be held hostage to the limitations identical to the traditional door! Excellent protection against heat loss - **Ud from 0.60 W/m²K** and the most favorable price-quality ratio, make them unrivaled in the world elite group of passive doors.

Standard equipment

thicker sash
in the same price

- composite sash **75 mm** with wood-like surface RealWood structure, optional: with smooth surface, or in any combination of both surface,
- PVC door frame 85 mm with wood-like surface RealWood structure or a smooth surface, optional: door frame of the highest quality meranti wood,
- door set finally painted with the highest quality lacquers in the full range of RAL colours or in the on of wood like decorations, *optional: painting in several freely configurable colours according to the order, optional: use of the pearl effect of any colour from RAL palette;*
- low aluminium threshold with thermal barrier, *optional: with the system of insulating profiles - see price list;*
- four 3D adjustable hinges with increased resistance to burglary;
- anti-theft blockade system;
- three-point anti-theft strip lock, locking by handle or automatic lock;
- a set of locking plates made of stainless steel;
- triple sealing system around the edges;
- wind-stop - seal in threshold part of the frame;
- in versions with glazing: triple glazing units with system of warm bar Super Spacer.

The price of the door to choose from is one of many designs of stained glass ornaments from groups I and II - details in the stained glass catalog available at www.vikking.eu

Optional equipment for an additional price. Customized implementations are available in wide range on request.

Available in many dimensions and variants, also with sidelights in any shape and size.

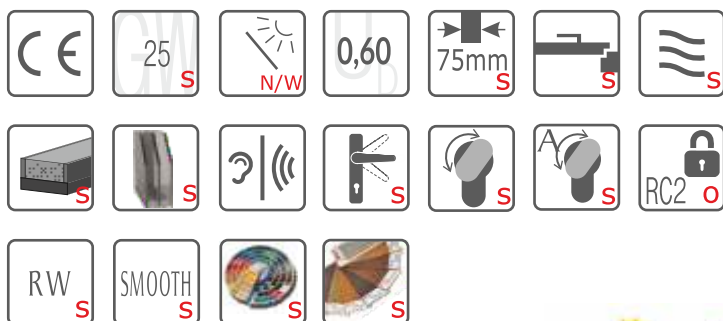

Optional equipment for an additional price

- handle or handrail
 - anti-burglar handle
 - key/key cylinder or key/knob either cylinder with one key system
 - normal escutcheon for upper lock or cylinder protection
 - levelling threshold cap
 - steel enhanced subliminal
 - electric switch or touch screen in the handrail
 - pointed LED light (only in straight handrail)
 - illuminated door sash
 - digital viewfinder
 - door closer with rail or arm
 - hidden door closer
 - contactron
 - electric strike or mechanical hook
 - BioKey - fingerprint reader or bluetooth keyboard.
- For more options, please ask your dealer.

By energy saving,
we care about
future generations.



ARCTIC

PERFECT FOR ENERGY EFFICIENT OR PASSIVE SINGLE-FAMILY HOUSES

External entry doors opened inward or outward

ARCTIC line - doors designed for demanding customers and those, who appreciate quality. Top class fittings and equipment complement this unique offer of door with excellent aesthetic and functional parameters. Door in connection with the PVC door frame are completely resistant to moisture.

It does not require roofs to protect them from sun and rain.
Protection against heat loss - U_p juž od 0,70 W/m²K

Standard equipment

- composite sash **65 mm** with wood-like surface RealWood structure, optional: with smooth surface, or in any combination of both surface,
- PVC door frame 85 mm with wood-like surface RealWood structure or a smooth surface, optional: door frame of the highest quality meranti wood,
- door set finally painted with the highest quality lacquers in the full range of RAL colours or in the on of wood like decorations,
optional: painting in several freely configurable colours according to the order,
optional: use of the pearl effect of any colour from RAL palette;
- low aluminium threshold with thermal barrier,
optional: with the system of insulating profiles - see price list;
- three 3D adjustable hinges with increased resistance to burglary;
- anti-theft blockade system;
- three-point anti-theft strip lock, locking by handle or automatic lock;
- a set of locking plates made of stainless steel;
- triple sealing system around the edges;
- wind-stop - seal in threshold part of the frame;
- in versions with glazing: triple glazing units with system of warm bar Super Spacer.

check what you will gain in standard

thicker sash



The price of the door to choose from is one of many designs of stained glass ornaments from group I; optional from group II
- details in the stained glass catalog available at www.vikking.eu

Optional equipment for an additional price. Customized implementations are available in wide range on request.

Available in many dimensions and variants, also with sidelights in any shape and size.

Optional equipment for an additional price

- handle or handrail
 - anti-burglar handle
 - key/key cylinder or key/knob either cylinder with one key system
 - normal escutcheon for upper lock or cylinder protection
 - levelling threshold cap
 - steel enhanced subliminal
 - electric switch or touch screen in the handrail
 - pointed LED light (only in straight handrail)
 - illuminated door sash
 - digital viewfinder
 - door closer with rail or arm
 - hidden door closer
 - contactron
 - electric strike or mechanical hook
 - BioKey - fingerprint reader or bluetooth keyboard.
- For more options, please ask your dealer.

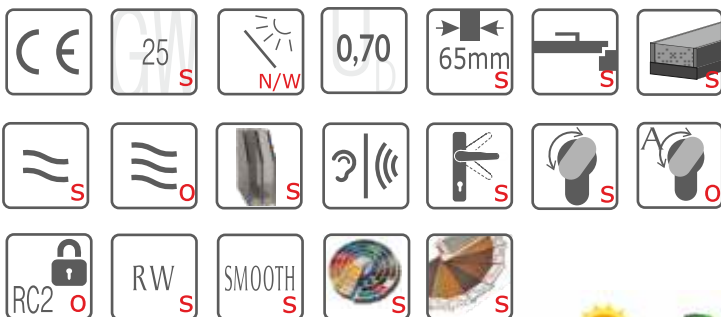

Billion possibilities



PREMIUM

PERFECT FOR ENERGY EFFICIENT HOUSES
External entry doors or internal doors opened inward or outward

Composite doors of Premium line is broadest offer for those, who's seeking excellent quality products that will protect your home for many years. In addition to the numerous functional and technical advantages the doors of this line are distinguished by the widest range of available sizes, colours, glazing, fittings and equipment at no extra hidden costs.

Protection against heat loss - U_g from 0,85 W/m²K

Standard equipment

- composite sash **54/45 mm** with wood-like surface RealWood structure, optional: with smooth surface, or in any combination of both surface,
- PVC door frame 70 mm with wood-like surface RealWood structure or a smooth surface, optional: door frame of the highest quality meranti wood,
- door set finally painted with the highest quality lacquers in the full range of RAL colours or in the on of wood like decorations, optional: painting in several freely configurable colours according to the order, optional: use of the pearl effect of any colour from RAL palette;
- low aluminium threshold with thermal barrier, optional: with the system of insulating profiles - see price list;
- three 3D adjustable hinges with increased resistance to burglary;
- anti-theft blockade system;
- three-point anti-theft strip lock, locking by handle or automatic lock;
- a set of locking plates made of stainless steel;
- double sealing system around the edges;
- wind-stop - seal in threshold part of the frame;
- in versions with glazing: triple glazing units with system of warm bar Super Spacer.

The price of the door to choose from is one of many designs of stained glass ornaments from group I; optional from group II - details in the stained glass catalog available at www.vikking.eu

Optional equipment for an additional price. Customized implementations are available in wide range on request.

Available in many dimensions and variants, also with sidelights in any shape and size.



Optional equipment for an additional price

- handle or handrail
- anti-burglar handle
- key/key cylinder or key/knob either cylinder with one key system
- normal escutcheon for upper lock or cylinder protection
- levelling threshold cap
- steel enhanced subliminal
- electric switch or touch screen in the handrail
- pointed LED light (only in straight handrail)
- illuminated door sash
- digital viewfinder
- door closer with rail or arm
- hidden door closer
- contactron
- electric strike or mechanical hook
- BioKey - fingerprint reader or bluetooth keyboard. For more options, please ask your dealer.



Perfect investment for generations

Glass packet in PRIVALIGHT technology

Protect your privacy when you want.

NEW



Electronically controlled glass with variable transparency.

When the current is switched on, the liquid crystal particles in the LC film take on a regular pattern, making the glass translucent.

After switching off the current, the LC film with liquid crystals changes its state and becomes opaque.



Diplomat S
Colour: RAL 9004



Diplomat 9
Colour: RAL 9006



Diplomat 0B
Colour: RAL 5008



Diplomat 0F
Colour: RAL 3032



Diplomat 0H
Colour: RAL 7040



Diplomat 0I
Colour: RAL 7037



Diplomat 0J
Colour: RAL 7043



Diplomat 0K
Colour: RAL 1035



Diplomat 0M
Colour: RAL 9006



Diplomat 0N
Colour: RAL 7037



Diplomat 0P
Colour: RAL 7036



Diplomat 0R
Colour: RAL 9007/7047



Diplomat 0T
Colour: RAL 7047/7043



Diplomat 0Z
Colour: RAL 9011



Diplomat A2
Colour: RAL 7043

All images in this offer have standard equipment and show only a small part of our offer.

In each model of composite doors, you can choose any colour, applications equipment and stained glass designs, The full offer being available on our website www.vikking.eu.



Diplomat A4
Colour: RAL 7001



Diplomat A5
Colour: RAL 7037



Diplomat A6
Colour: RAL 7016



Diplomat A7
Colour: RAL 7043



Diplomat A8
Colour: RAL 7037



Diplomat B3
Colour: RAL 1035



Diplomat B1
Colour: Dark oak/RAL 1036



Diplomat B2
Colour: RAL 9016/golden oak



Diplomat B4
Colour: RAL 7040



Diplomat B6
Colour: RAL 7047



Diplomat C3
Colour: RAL 9016/1035



Diplomat C4
Colour: RAL 1035

According to printing quality, colours can be different in real. We advice to check witch colour templates available in stores.



Diplomat 20
Colour: RAL 7021



Diplomat 2D
Colour: RAL 7043



Diplomat 2F
Colour: RAL 1035



Diplomat 2G
Colour: RAL 5008



Diplomat 2H
Colour: RAL 7036



Diplomat 2i
Colour: RAL 7036

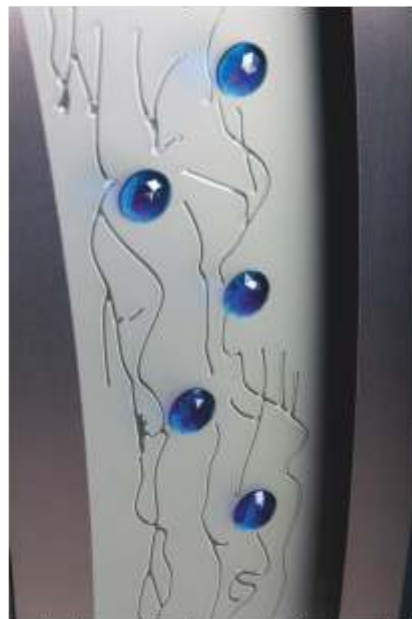

Diplomat 30
Colour: RAL 7026

Dedicated stained glass
More variants in stained glass offer, which you can find on vikking.eu

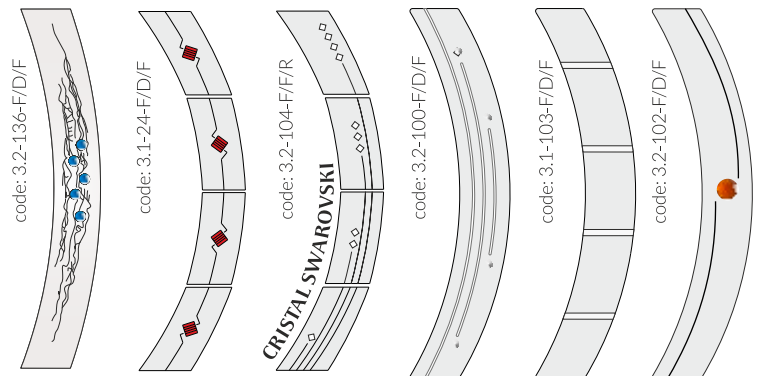

All images in this offer have standard equipment and show only a small part of our offer. In each model of composite doors, you can choose any colour, applications equipment and stained glass designs, The full offer being available on our website www.vikking.eu



Diplomat 1D
Colour: RAL 9006/7021



Diplomat 14
Colour: RAL 7043



Diplomat 1W
Colour: RAL 7002



Diplomat 3Y
Colour: RAL 7043/9006



Diplomat 38
Colour: RAL 1036



Diplomat 39
Colour: RAL 7047



Diplomat 3Z
Colour: RAL 9016/7016



Diplomat 46
Colour: RAL 7043



Diplomat 4H
Colour: RAL 7040



Diplomat 3Z
Colour: RAL 7016



Diplomat 4J
Colour: RAL 1035



Diplomat 4N
Colour: RAL 7006

According to printing quality, colours can be different in real. We advice to check witch colour templates available in stores.



Diplomat 4P
Colour: RAL 7040



Diplomat 4U
Colour: RAL 7043



Diplomat 4V
Colour: RAL 1035



Diplomat 4W
Colour: RAL 9016/7036



Diplomat 4X
Colour: RAL 8019



Diplomat 4Y
Colour: RAL 7036/9016



Diplomat 4Z
Colour: RAL 7046



Diplomat 5D
Colour: RAL 7037



Diplomat 5E
Colour: RAL 9006



Diplomat 5F
Colour: RAL 7043



Diplomat 5G
Colour: RAL 7047



Diplomat 5H
Colour: RAL 7006



Diplomat 5L
Colour: RAL 9011/7006



Diplomat 5M
Colour: RAL 1036



Diplomat 5N
Colour: golden oak/RAL 7040

All images in this offer have standard equipment and show only a small part of our offer. In each model of composite doors, you can choose any colour, applications equipment and stained glass designs, The full offer being available on our website www.vikking.eu.



Diplomat 5R
Colour: RAL 9010/5004



Diplomat 5T
Colour: RAL 7036



Diplomat 5U
Colour: RAL 7016



Diplomat 5V
Colour: RAL 7040



Diplomat 5W
Colour: RAL 8019/9018



Diplomat 5Y
Colour: RAL 3007



Diplomat 5X
Colour: RAL 9011

Dedicated stained glass
More variants in stained glass offer, which you can find on vikking.eu

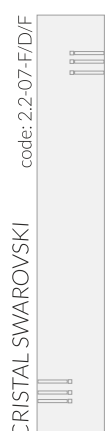
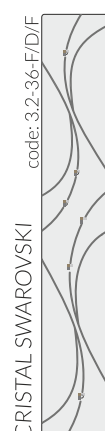
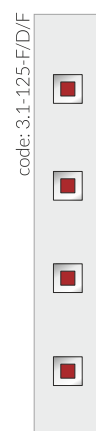

According to printing quality, colours can be different in real. We advice to check witch colour templates available in stores.



Diplomat 11
Colour: RAL 7006



Diplomat 1H
Colour: RAL 7037



Diplomat 1i
Colour: RAL 7016



Diplomat 5V
Colour: RAL 7046



Diplomat 1L
Colour: RAL 5014



Diplomat 1M
Colour: RAL 9016/7043



Diplomat 1N
Colour: RAL 1035



Diplomat 1P
Colour: RAL 7006



Diplomat 1S
Colour: RAL 1035



Diplomat 1T
Colour: RAL 7047



Diplomat 1V
Colour: RAL 1035



Diplomat 40
Colour: RAL 1036



Diplomat 4E
Colour: RAL 7036

Dedicated stained glass
More variants in stained glass offer,
which you can find on vikking.eu



code: 6.1-108-F/D/F

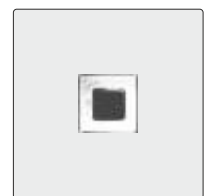

code: 6.1-11-F/D/F

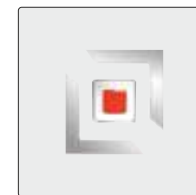

code: 6.2-04-F/D/F



code: 2.1-10-D/F/D

All images in this offer have standard equipment and show only a small part of our offer.
In each model of composite doors, you can choose any colour, applications equipment and stained glass designs, The full offer
being available on our website www.vikking.eu.



Diplomat 31
Colour: RAL 7016



Diplomat 32
Colour: RAL 9023



Diplomat 33
Colour: RAL 7046



Diplomat 41
Colour: RAL 7036



Diplomat 44
Colour: RAL 7043



Diplomat 52
Colour: RAL 7031



Diplomat 53
Colour: RAL 8019



Diplomat 54
Colour: RAL 9016/7043



Diplomat 8N
Colour: RAL 9018



Diplomat 26
Colour: RAL 3007



Diplomat 1A
Colour: RAL 7043



Diplomat 36
Colour: RAL 9016/
7047/7000



Diplomat 55
Colour: RAL 5014

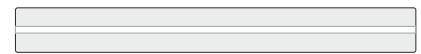

code: 3.1-41-F/D/F



code: 5.1-39-F/D/F

CRISTAL SWAROVSKI



code: 5.1-111-F/D/F



code: 3.1-02-F/D/F

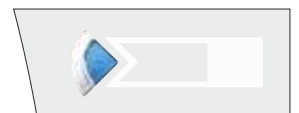

code: 2.3-20-F/D/F

According to printing quality, colours can be different in real. We advice to check witch colour templates available in stores.



Diplomat 6i
Colour: RAL 7047



Diplomat 6j
Colour: RAL 7016



Diplomat 6H
Colour: RAL 7036



Diplomat 66
Colour: RAL 5008



Diplomat 68
Colour: RAL 7043



Diplomat 7F
Colour: RAL 1035



Diplomat 7J
Colour: RAL 7036



Diplomat 7K
Colour: RAL 7006



Diplomat 7L
Colour: RAL 7043

Dedicated stained glass
More variants in stained glass offer,
which you can find on vikking.eu

code: 3.2-94-F/D/F



code: 3.2-51-F/D/F

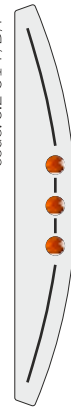

code: 3.1-129-F/D/F



code: 3.2-93-F/D/F

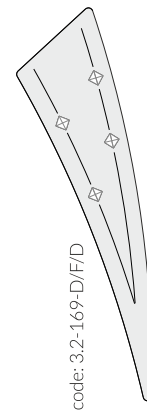
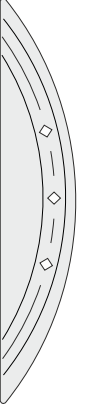

code: 3.2-169-D/F/D

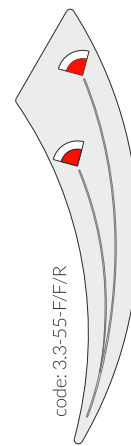

code: 3.3-55-F/F/R

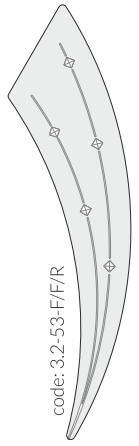

code: 3.2-53-F/F/R

code: 3.1-78-F/D/F



code: 3.1-79-F/D/F



code: 3.1-56-F/D/F



code: 3.2-57-F/D/F



code: 3.2-58-F/D/F

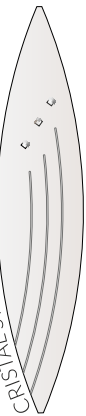

All images in this offer have standard equipment and show only a small part of our offer.

In each model of composite doors, you can choose any colour, applications equipment and stained glass designs, The full offer being available on our website www.vikking.eu.



Diplomat 8D
Colour: RAL 7036/9016



Diplomat 8J
Colour: RAL 9010/7043



Diplomat 8K
Colour: RAL 9016/7043



Diplomat 8F
Colour: RAL 7016



Diplomat 8M
Colour: RAL 9006



Diplomat 8R
Colour: RAL 1035

Dedicated stained glass
More variants in stained glass offer,
which you can find on vikking.eu

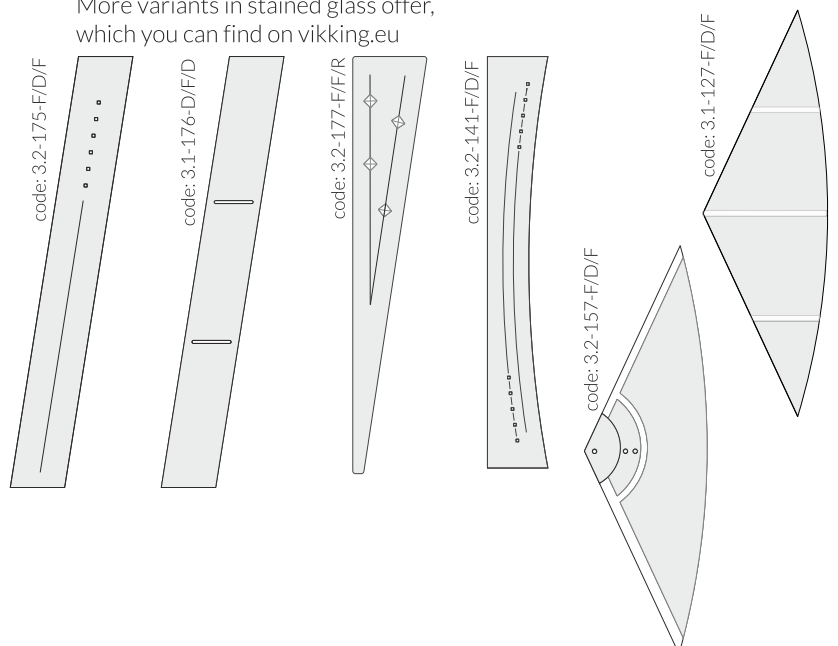

According to printing quality, colours can be different in real. We advice to check witch colour templates available in stores.



Diplomat 8C
Colour: RAL 9016/5004



Diplomat 8G
Colour: RAL 1035



Diplomat 8H
Colour: RAL 9001



Diplomat 8i
Colour: RAL 9016/7043



Diplomat 8P
Colour: RAL 7043

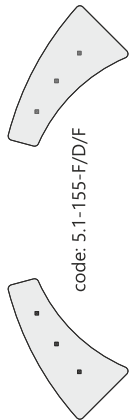

code: 5.1-155-F/D/F



Diplomat 8S
Colour: RAL 9023



Diplomat 5J
Colour: RAL 7006



Diplomat 8L
Colour: RAL 7036

Dedicated stained glass
More variants in stained glass offer,
which you can find on vikking.eu

code: 3.2-155-F/D/F

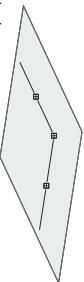

code: 3.1-156-F/D/F



code: 3.2-146-F/D/F



NEW
code: 3.2-189-F/D/F

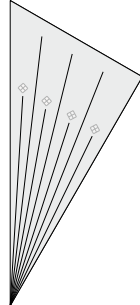

NEW
code: 2.1-190-F/D/F

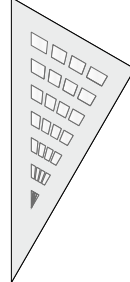

All images in this offer have standard equipment and show only a small part of our offer. In each model of composite doors, you can choose any colour, applications equipment and stained glass designs, The full offer being available on our website www.vikking.eu.



Diplomat B7
Colour: RAL 1035

Stone application



Highlight your door with an original natural stone application, available in many variants.



Bari

Venezia

Merano

Roma

Siena

Thanks to perpetual decor combinations, everyone can award his house with beautiful showcase which entry doors really are.

Configure your own doors or take an advice from our sellers. Combine structures, colours, decoration elements and create doors of your dreams.

Stone Collection

Natural stone application available only in VIKKING composite entry doors.



Diplomat C1
Colour: RAL 7046/7047



Diplomat C2
Colour: RAL 9010/8019



Diplomat 5S
Colour: RAL 9010



Diplomat 8E
Colour: RAL 9016



Diplomat 8W
Colour: RAL 1035

According to printing quality, colours can be different in real. We advice to check witch colour templates available in stores.



Ambassador 2
Colour: Walnut



Ambassador 1
Colour: Italian walnut



Ambassador 2A
Colour: Swamp oak

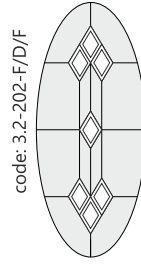

code: 3.2-202-F/D/F

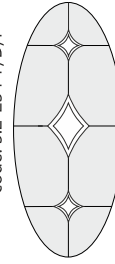

code: 3.2-234-F/D/F

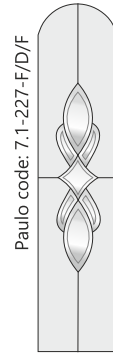

Paulo code: 7.1-227-F/D/F

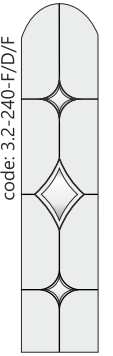

code: 3.2-240-F/D/F

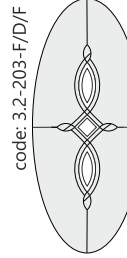

code: 3.2-203-F/D/F



code: 7.1-228-F/D/F



code: 2.2-223-F/D/F

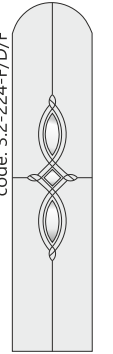

code: 3.2-224-F/D/F



President 1
Colour: Dark oak



President 2
Colour: Golden oak



Attache 2
Colour: RAL 8017



Attache 4A
Colour: RAL 8017



code: 3.1-506-F/D/F



code: 3.1-507-F/D/F



Attache 5
Colour: Golden oak



Attache 10
Colour: Walnut



Attache 13
Colour: Golden oak



Attache 14
Colour: Walnut

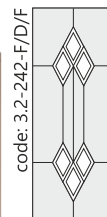

code: 3.2-242-F/D/F

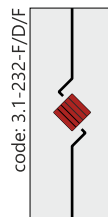

code: 3.1-232-F/D/F

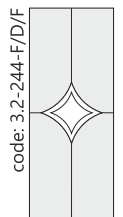

code: 3.2-244-F/D/F

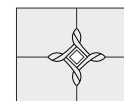

code: 3.2-233-F/D/F

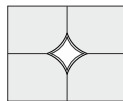

code: 3.2-215-F/D/F

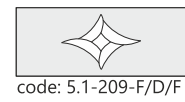

code: 5.1-209-F/D/F



code: 3.1-208-F/D/F



Consul 2
Colour: Dark oak



Consul 4
Colour: RAL 9016



Consul 3
Colour: Dark oak



Attention! Consul doors have horizontal wood grain in the above marked area.



Consul 5
Colour: RAL 7040



Consul 6
Colour: RAL 9016



Consul 7
Colour: Walnut



Eminence N1
Colour: RAL 5011



code: 3.2-218-F/D/F

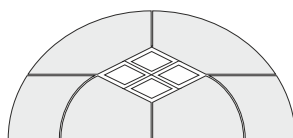

code: 3.2-229-F/D/F

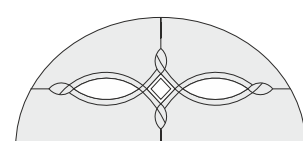

code: 3.2-231-F/D/F *

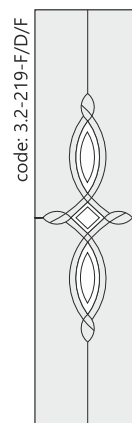

code: 3.2-219-F/D/F

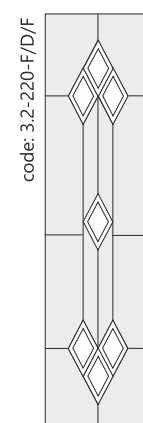

code: 3.2-220-F/D/F

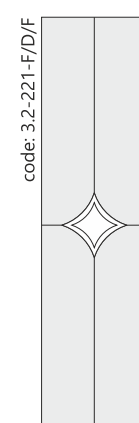

code: 3.2-221-F/D/F



Bevels - the beauty of grinded glass



Swarovski - jewellery for your doors



Fusing - colours embedded onto glass

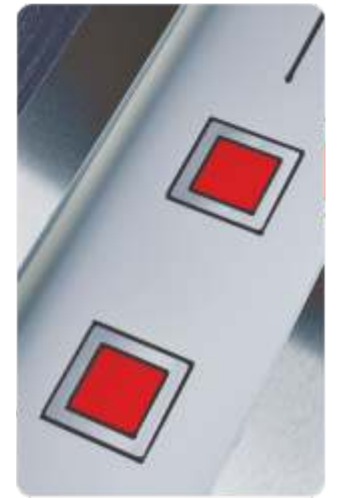

Resin - multiplicity of colours



LED lighting - bright accent of your home



Frozen and melted glass - individual style and charm



All glazings are decorated in our GLASS & STAINED GLASS STUDIO
the most beautiful styles - in standard and at the individual customer's request

Selected colours from RAL palette

Below, we present the colours most commonly chosen by our customers. Our customers have access to a full range of RAL (except for pearl, metallic and luminous) and they decide about the colour of their dream doors.



*Metallic and fluorescent colors available on an individual order.

NOWOŚĆ

Colours from RAL palette with PEARL effect

NOWOŚĆ

* Details on page 9 of the catalog - additional payment for the use of the pearl effect in the table of additional payments in the price list.

Wood grain colours

For lovers of precious wood colours, we offer from one of the many decorations created by our craftsmen with the highest qualifications.



Composite doors VIKKING can be painted in two colours (divided into the outer side and an inner side), as well as several colours on each side.



Side lights and transoms variants - perfectly fitted to your needs

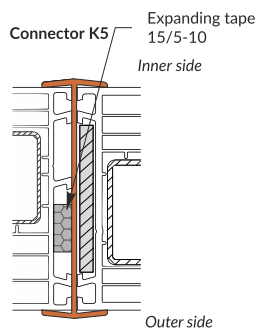
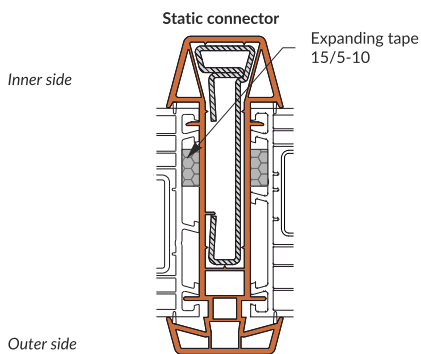
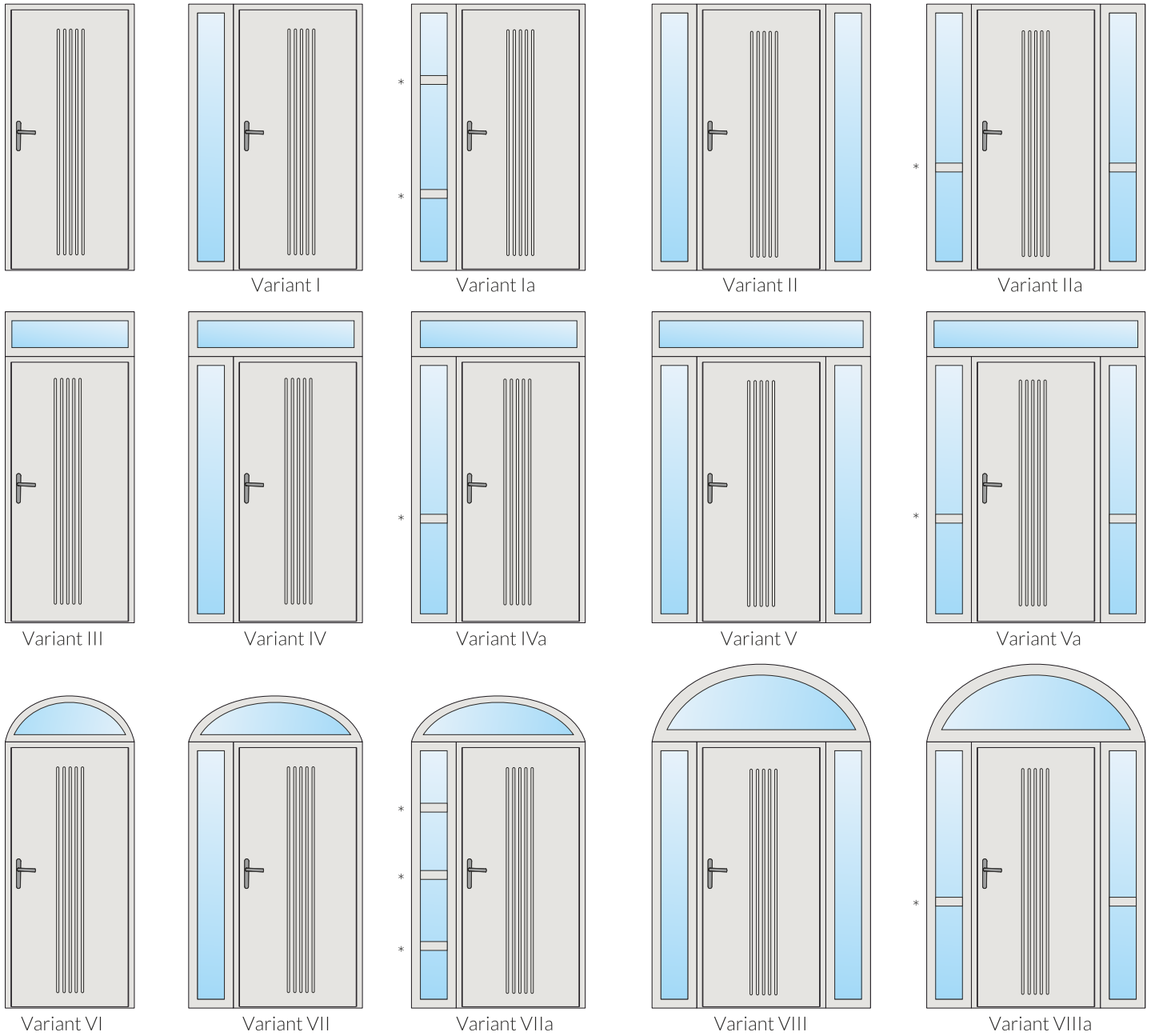

Perfect connection

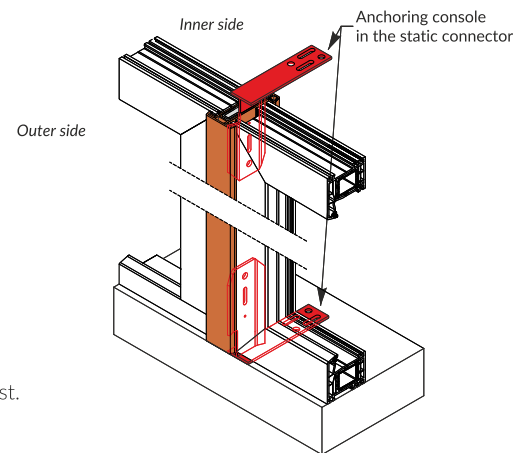

The sidelights of composite doors are manufactured in any variants, sizes and decorations.
 * Sidelight lacing. The number and configuration of the lacings according to the order - optional, see price list.
 Types of sidelight fillings:

- triple glazed decorated glass unit in the design identical as stained glass of the sash,
 - filling with composite panel of the structure and colors identical with the door sash.
- Optional: composite panels filled with glazing unit in the design identical as stained glass of the sash - individual pricing.

Do you expect different shape? - we find together the optimal solution.
 Please contact with us: wyceny@vikking.eu



For your convenience and security all doors in rebate version stand out for the highest-quality multi-point, anti-theft strip locks.

Locks dedicated to the lines: ARCTIC PLUS and ARCTIC

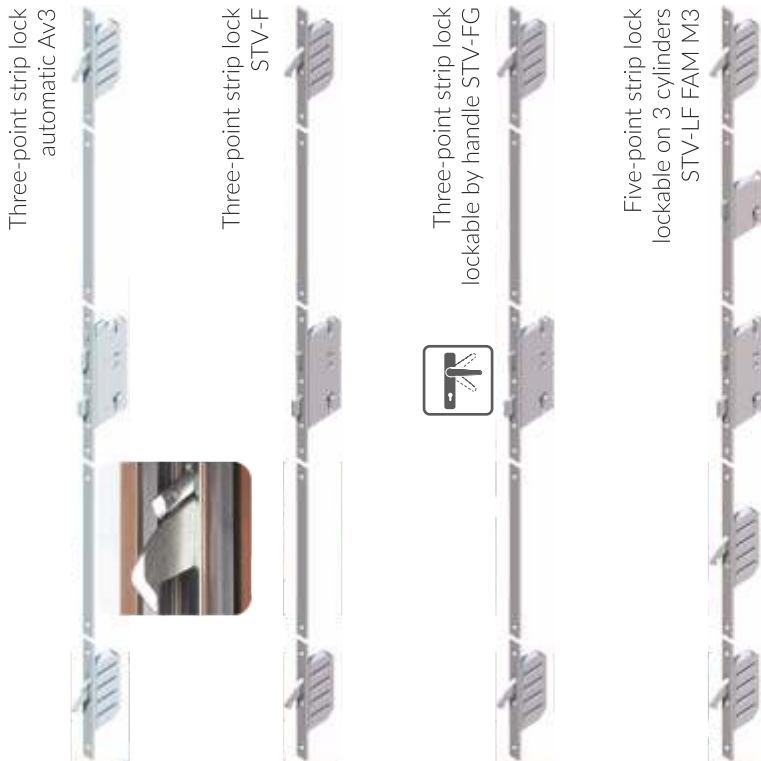

Locks dedicated to the PREMIUM line

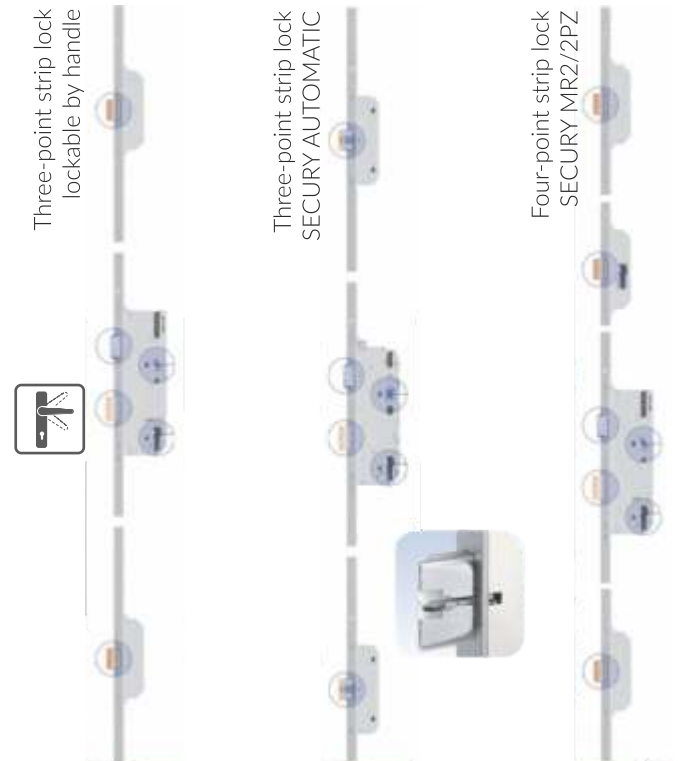

Locking plate made of stainless steel

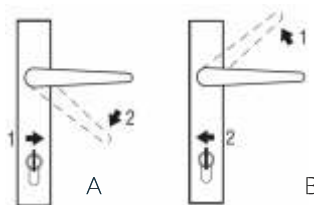

- * Locking with use of door handle
- A) Opening:
1. Unlock the door lock using the key.
 2. Open using a door handle.
- B) Closing:
1. Lock the door by lifting the handle up.
 2. Close using the key.

It is recommended to use a door closer to the electric door strike and the mechanical latch, which will protect the sash against opening due to draft.



Hidden door closer GEZE



Door closer GEZE



day
night

Mechanic door strike to the Av3 lock with day/night function



nickel - satin f9



old gold f4



white



Door closer GEZE with arm

Only in composite doors hinges are flushed with the sash, are adjustable in three dimensions (3D), don't require maintenance. Always in the colour identical to fittings with no hidden surcharges for the covers.

Highest Swiss quality!



AXA Solo Handle

DEDICATED FOR AXA AMSTERDAM HANDRAIL



NEW

Handle AXA Mars



Handle HOPPE with fingerprint reader



BioKey - Your biometric key

Fingerprint reader BioKey - Your biometric key

Put your @registered@ finger to the reader and slide it over the surface, and your door will open automatically. After you pass the threshold - built-in door pusher will take care of the immediate shut of the door, and automatic locking device will lock it again. If you want, you can unlock it using a key from outside and a handle from inside.

Fingerprint reader can be easily added to intelligent home system.

Just forget about a bunch of keys, incidentally locked door.

Glass keyboard with Bluetooth system.

The solution is very simple, which give you possibility to open your doors by the keyboard code or with telephone/smatphone with bluetooth function.

Lock operating in composite doors have never been so comfortable.

You don't need keys, use only telephone with bluetooth.

In the system you can have 6 phones and 18 numeric codes.

The keyboard cooperate with intelligent house system.

RFID is another fast and trouble-free door unlocking system. It is also possible to open the door with all already existing transponders such as: business access card, credit card, ATM card, tags, key rings etc. It is a radio wave system.





Handrail P45
Colour INOX
• 580 mm
• 800 mm
• 1000 mm
• 1200 mm
• 1400 mm
• 1600 mm
• 1800 mm



Handrail P45B
Colour INOX
• 580 mm
• 870 mm



Handrail Q45
Colour INOX
• 580 mm
• 800 mm
• 1000 mm
• 1200 mm
• 1400 mm
• 1600 mm
• 1800 mm



Handrail P10B
Colour INOX
• 1650 mm



Handrail AXA Amsterdam
Colour INOX
• 800 mm
• 1200 mm
• 1500 mm



Colour F8
black

Colour F4
old gold

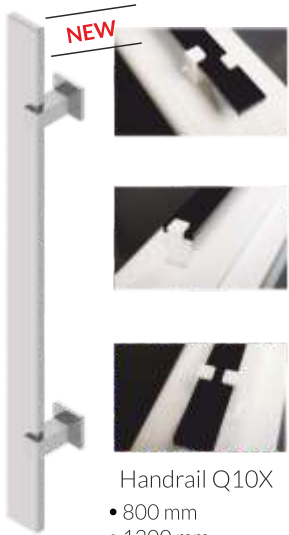

NEW

Handrail Q10X

- 800 mm
- 1200 mm
- 1400 mm
- 1800 mm



NEW

Handrail K1
• 150x250 mm



NEW

Handrail K1P
• 155x550 mm



Handrail Lestol KPL
Colour INOX
• 1750 mm

NEW

Handrail PS
• 1800 mm
• 2000 mm
• 2200 mm



Touch sensor



Microswitch in handrail

Viewfinder AXA DDS2
(integrated doorbell)



Inner side



Outer side



LED light in handrail



DIPLOMAT / ATTACHE							
ARCTIC Plus / ARCTIC sash thickness: 75 / 65 mm frame depth: 85 mm			The height of the hole in the wall				
	frame ext. dim.	900	2000	2050	2100	2150	2200
	frame int. dim.		870 x 1980	870 x 2030	870 x 2080	870 x 2130	870 x 2180
	frame ext. dim.	950	710 x 1880	710 x 1930	710 x 1980	710 x 2030	710 x 2080
	frame int. dim.		920 x 1980	920 x 2030	920 x 2080	920 x 2130	920 x 2180
	frame ext. dim.	1000	760 x 1880	760 x 1930	760 x 1980	760 x 2030	760 x 2080
	frame int. dim.		970 x 1980	970 x 2030	970 x 2080	970 x 2130	970 x 2180
	frame ext. dim.	1050	810 x 1880	810 x 1930	810 x 1980	810 x 2030	810 x 2080
	frame int. dim.		1020 x 1980	1020 x 2030	1020 x 2080	1020 x 2130	1020 x 2180
	frame ext. dim.	1100	860 x 1880	860 x 1930	860 x 1980	860 x 2030	860 x 2080
frame int. dim.	1070 x 1980		1070 x 2030	1070 x 2080	1070 x 2130	1070 x 2180	
			910 x 1880	910 x 1930	910 x 1980	910 x 2030	910 x 2080
PREMIUM sash thickness: 54 mm; frame depth: 70 mm			The height of the hole in the wall				
	frame ext. dim.	900	2000	2050	2100	2150	2200
	frame int. dim.		870 x 1980	870 x 2030	870 x 2080	870 x 2130	870 x 2180
	frame ext. dim.	950	738 x 1894	738 x 1944	738 x 1994	738 x 2044	738 x 2094
	frame int. dim.		920 x 1980	920 x 2030	920 x 2080	920 x 2130	920 x 2180
	frame ext. dim.	1000	788 x 1894	788 x 1944	788 x 1994	788 x 2044	788 x 2094
	frame int. dim.		970 x 1980	970 x 2030	970 x 2080	970 x 2130	970 x 2180
	frame ext. dim.	1050	838 x 1894	838 x 1944	838 x 1994	838 x 2044	838 x 2094
	frame int. dim.		1020 x 1980	1020 x 2030	1020 x 2080	1020 x 2130	1020 x 2180
	frame ext. dim.	1100	888 x 1894	888 x 1944	888 x 1994	888 x 2044	888 x 2094
frame int. dim.	1070 x 1980		1070 x 2030	1070 x 2080	1070 x 2130	1070 x 2180	
			938 x 1894	938 x 1944	938 x 1994	938 x 2044	938 x 2094
PRESIDENT / AMBASSADOR / CONSUL / EMINENCE							
ARCTIC Plus sash thickness: 75 mm frame depth: 85 mm				The height of the hole in the wall		Comments	
	frame ext. dim.	width of the hole in the wall	1040	2090			
	frame int. dim.			1010 x 2070		Only PRESIDENT	
				850 x 1970			
ARCTIC sash thickness: 65 mm frame depth: 85 mm				The height of the hole in the wall			
	frame ext. dim.	width of the hole in the wall	1040	2090			
	frame int. dim.			1010 x 2070			
				850 x 1970			
PREMIUM sash thickness: 54 mm frame depth: 85 mm				The height of the hole in the wall			
	frame ext. dim.	width of the hole in the wall	950	2080	2090		
	frame int. dim.			920 x 2060		Only PRESIDENT	
	frame ext. dim.			1030	788 x 1974		
	frame int. dim.				1000 x 2060		
	frame ext. dim.			1050	868 x 1974		
frame int. dim.					1020 x 2070	Only AMBASSADOR	
				888 x 1984			

Thickness of the door Eminence and Ambassador remain like previous (A+ 68mm; A 60mm; P 45mm)

Other sizes of doors on a separate query wyceny@vikking.eu

frame ext. dim. - S1xH1 height of the hole in the wall - H2; frame int. dim. - S0xH0 width of the hole in the wall - S2.
Dimension tolerance according to PN: up to 1m: +/- 1mm; over 1m: +/- 2mm.

Optional: all door models may have a door frame extensions - see price list. Double doors, sidelights, transoms and custom projects (with the exceptions of technical limitations) are carried out according to individual orders - please contact us: wyceny@vikking.eu or bok@vikking.eu

Dedicated for mounting doors from the Arctic group in the insulation layer

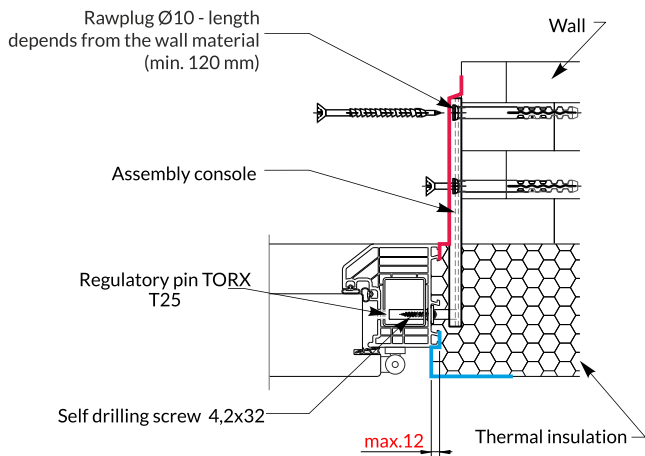

Dedicated to the assembly of doors from the Arctic group in the masonry layer with the use of turboscrews

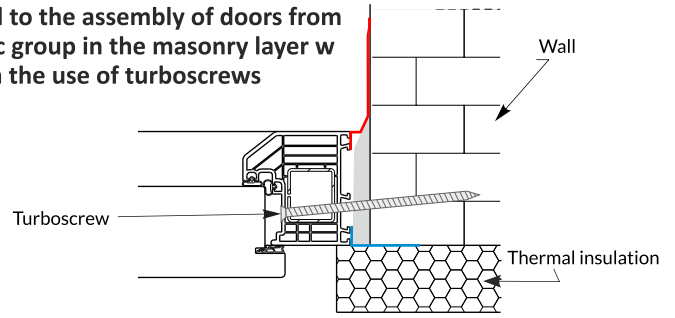

Dedicated assembly of doors from Premium line

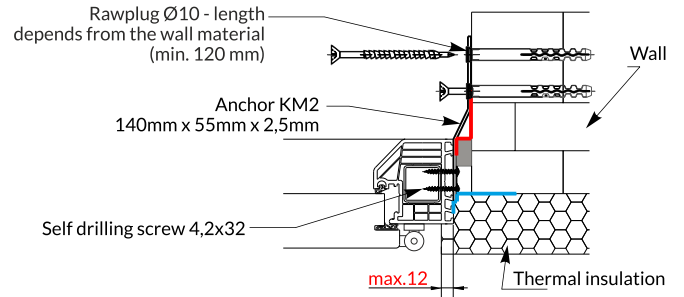

Optimal anchorage points of doors and sidelights

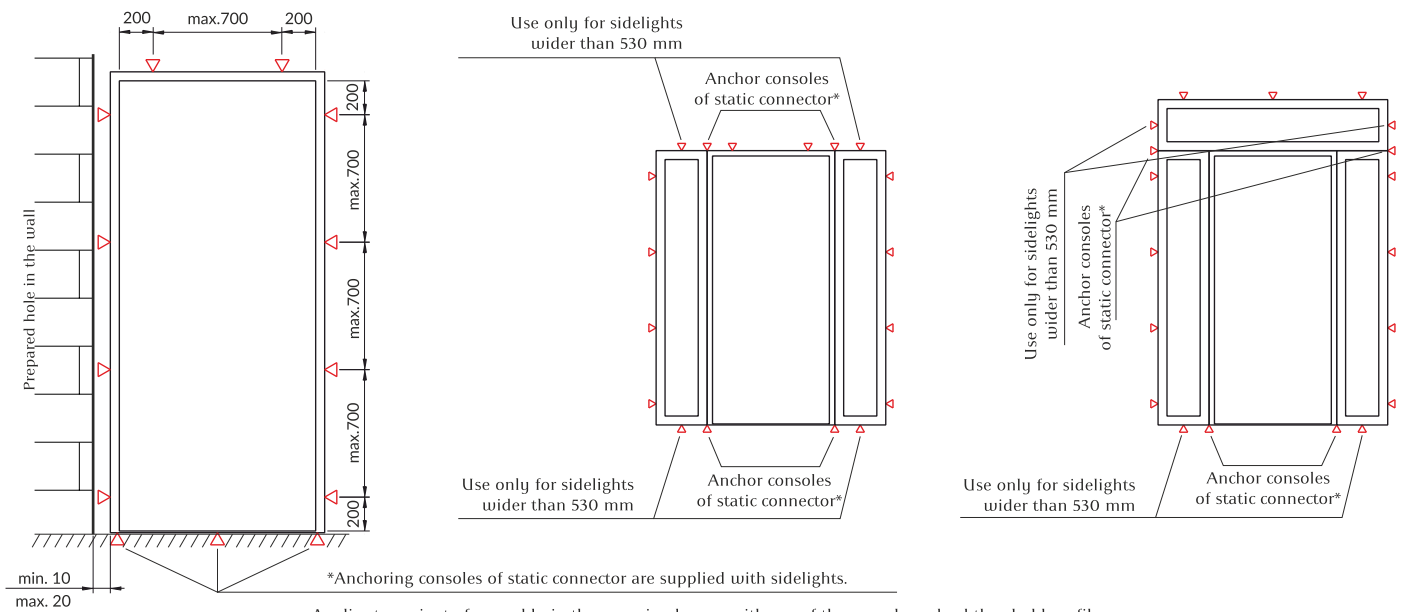

Recommended positioning of a door on subthreshold profile and insulation of threshold section

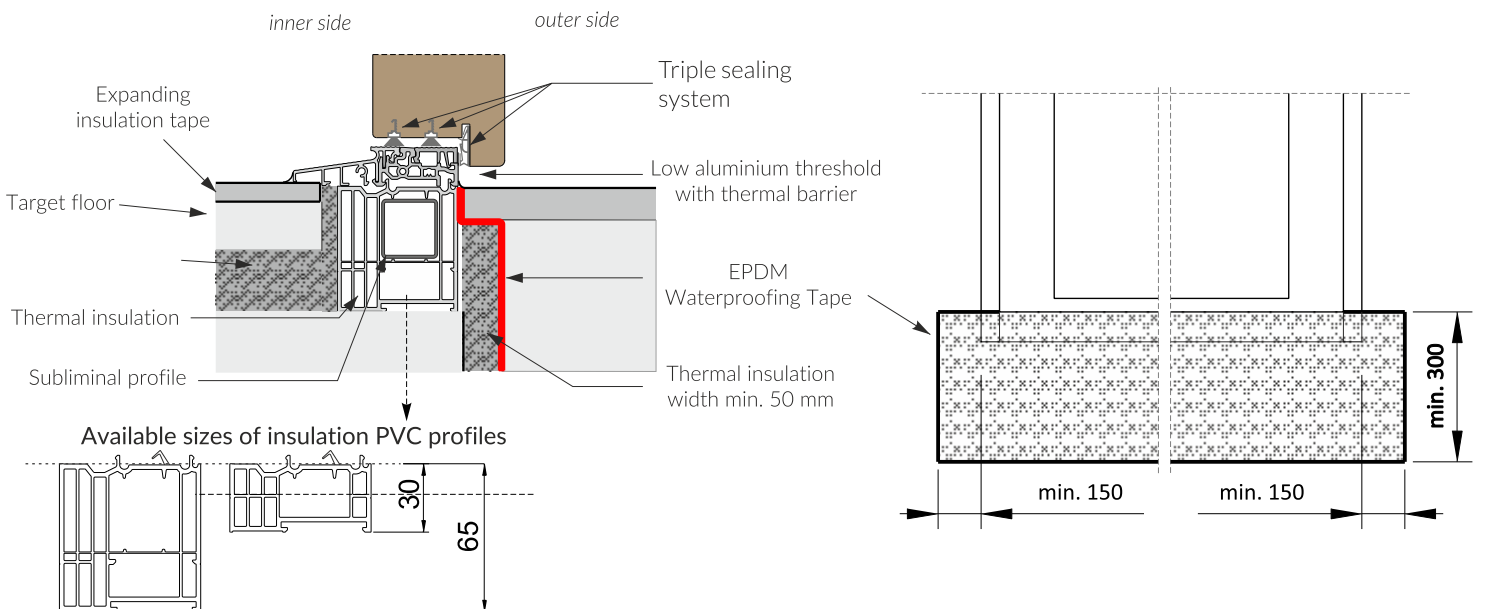

Detailed guidelines of composite doors assembly available for partners on: <http://strefa-partnera.vikking.eu>

The system advantage - see the difference

If You don't know, what you should choose - compare the parameters of individual lines.

Pay particular attention to the:

- solid confirmed by a written manufacturer guarantee,
- resistance door to climatic conditions - especially moisture ,
- insulation effectiveness, expressed by ratio Ud- the lower value , greater protectio, agai, st the loss of valuable e,ergy
- safety according PN-EN 1627:2011,
- available door and sidelights sizes,
- equipment, colours and glazing.

If you are not shure - compare the performance , solid and our doors price to any offer from another manufacturer.

X - Insert the parameters of the other door and compare to composite doors offer .

Name		ARCTIC Plus	ARCTIC	PREMIUM	X
Thermal insulation - W/m ² K		from 0,60	from 0,70	from 0,85	
Burglar cl RC 2		S*	S*	S*	
Requirement for full roof		N/D	N/D	O**	
Guarantee	sash	25 years	25 years	20 years	
	PVC door frame	20 years	20 years	20 years	
	Paint coatings	5 years	5 years	5 years	
	another components	3 years	3 years	3 years	
PVC door frame- 6-chamber cl A+		S	S	S	
Meranti door frame		O	O	O	
Composite sash		75 mm	65 mm	54 mm	
SMOOTH surface		S	S	S	
Real Wood surface		S	S	S	
Door with XXL size	max 1150 mm x 2400 mm	O	O	O	
The possibility of shortening and narrowing the door		O	O	O	
Sidelights, Toplights and individual doors		O	O	O	
Numbers of seals		3	2	2	
Low aluminium threshold with thermal barrier		S	S	S	
3D adjustable hinges in fittings colours with sets of security blockades		S	S	S	
3-point strip lock lockable by handle		S	S	S	
3-point automatic strip lock		S	O	O	
4-point strip lock lockable by the cylinder		N/D	N/D	O	
5-point strip lock lockable by cylinder		O	O	N/D	
Strip locks of stainless steel		S	S	S	
Painted with full range of RAL colours (except pearlescent colours , fluorescent and metallic)		S	S	S	
Painted by real wood decors		S	S	S	
Multicolored painted		O	O	O	
Thriple glazed units with Super Spacer warm edges		S	S	S	

S - standard

O - optional

W - required

N/D - not applicable

* It applies to complete doors with burglary inserts and handles

**Recommended for the door coating in dark colours

PVC DOORS OFFER



hidden hinges

perpetual configuratio



- profile system:
 - aluplast Ideal 7000 o profile depth 85mm
 - aluplast Ideal 4000 o profile depth 70mm
- completing with glazing units or PVC panel
- structural pasting system
- different shapes
- low aluminium threshold
- widening profile systems
- horizonatal and vertical battens
- full RAL palette colouristics or many woodgrain decorations



REALWOOD

ENERGY EFFICIENT WINDOWS

THE ONLY ONE **PVC** WINDOWS ON THE MARKET WITH **REAL WOOD** DECORATION

Unique decoration system made by our team of engineers, is the object of international patent protection.

PVC surface decoration in RW technology eliminate veneering profiles necessity and ensures durability for years.

Real Wood windows not require expensive maintenance opposite to wooden windows.



FIT PERFECTLY TO COMPOSITE DOORS



Innovative idea

Wooden products, during operation in the facilities are vulnerable to many threats from destructive effect of moisture on the hygroscopic wood construction. From here was born the idea of decorating the surface of PVC profiles, to provide them with the aesthetics of the fine wood and eliminate the effects and nuisance caused by the use of wood.

Innovative technology

The proprietary solution of structural glazing inserts prevents the sashes from falling, increases safety and comfort of use. It also allows you to optimize the steel reinforcements of window profiles, which greatly affects protection against the loss of valuable energy.

Decorated PVC profiles technology RealWood, unlike wood does not require care for protection against the weather. Any coatings repairs are also possible in the facility where windows are already mounted.

Innovative design

Developed by a team of VIKKING engineers proprietary technology is the subject of international patent protection. The attractiveness of the acquired visual effects provoked us also to reserve an international industrial design.

The surface of Real Wood window profiles resembles the surface of fine wood, but with no flaws that wood has. Real Wood decoration and varnishing can be made in any configuration. Real Wood windows, unlike veneer windows, always have all visible niches painted in a color identical to the color of the windows.



SPACE COMFORT

Terrace doors and windows systems:

- **tilt-turn:** the ability to use hinges discreetly hidden in the neutral rebate or magnetic sensors to monitor the positions of windows, climate control and operation of the hood and cooperating the alarm system.
- **tilt and slide:** comfortably system duoPort SK for large glazing, compatible with the latest trends. It ensures smooth operation and the possibility of increasing resistance to burglary.
- **retract and slide:** System duoPort PAS sliding doors gives a new dimension of functionality. The parallel withdrawal wings of the frame enables natural, energy-efficient ventilation, also in the absence of the household. The position of the parallel withdrawal wing fitting has the same class of burglary resistance as in the closed position.
- **HST lift and slide:** the possibility of making construction up to 6 meters wide. Thanks to the use of the highest quality fittings, the wings move freely and with respect to the unresolved parts of the structure freely and without the slightest resistance.



REVOLUTIONARY AIRING



Energy saving airing, without drafts.

Parallel positioning system 6 mm.

During the ventilation window meets the requirements of ENV 1627-1630 Class Rc2, which acts as a closed window shutters.



REALCOMFORT



Innovative technologies.
Functional solutions.



Freedom of shapes



Rich choice of handles

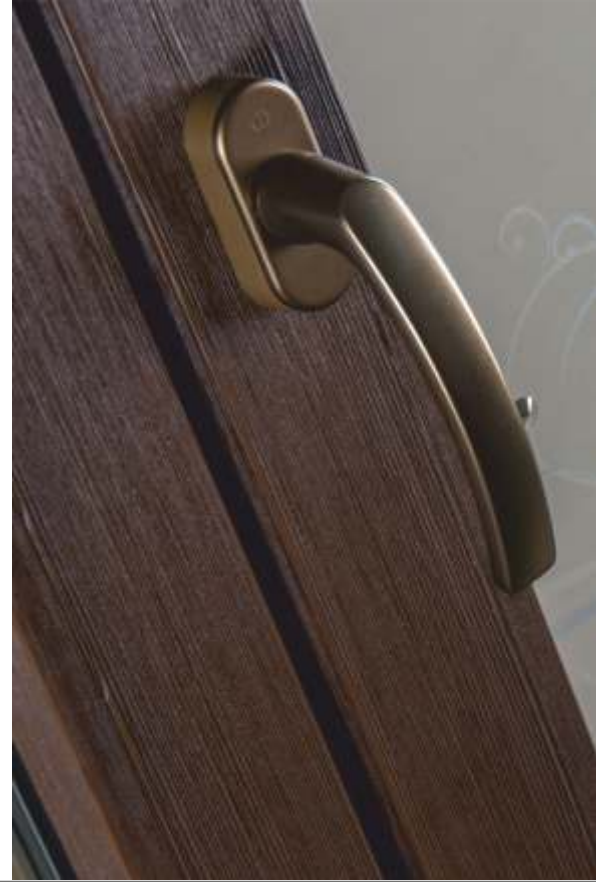

Together we will choose the best solutions dedicated to your needs.

Align the windows to the functionality of premises in your house.

Innovative design.

Colouristics not available in other systems.

Energy saving solutions.

Perpetual equipment configuration possibilities.

Durability for generations.

We are not afraid of even the most crazy projects.

Leading components suppliers:



Always precise





The pioneer of the personalized joinery.

Winner of prestigious competitions and polls.

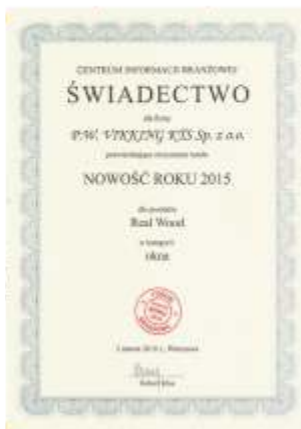

All information contained in this publication are given only for promotional purposes and may not be the subject of a binding offer. This catalog is valid from 1.08.2018. This day invalidates all previous publications and offers. Individual production process, the differences in wood graining, colours and structure of the door surface, as well as manually created stained glass decorations making all the composite doors VIKKING unique and cannot form the basis for a complaint.

Due to the printing conditions, presented colors and designs may vary slightly from the actual and should not be regarded as binding. The manufacturer reserves the right to technical improvements and changes in assortment.

Prior to installation of the door, please read the "Installation, use and maintenance of composite door" and warranty terms, omissions to do this may invalidate the warranty.

We make every effort to to produce an accurate catalogue with full thorough knowledge of the offer, however we are not responsible for inaccuracies. This publication is protected by copyright law and the reproduction of it, even partial, requires the consent of the manufacturer.

Composite doors and windows Real Wood are manufactured on the basis of our own, original technologies. Their innovation is confirmed by granted us the right to international patent protection. Unlawful infringement of intellectual property will be principle to investigate the claim for compensation.



Distributor:

Two empty rectangular boxes with L-shaped corner lines, intended for entering distributor information.

The material is for informational purposes and does not constitute an offer within the meaning of the law

Manufacturer

P.W. VIKKING KTS Sp. z o.o. • 21-500 Biała Podlaska • Aleja Solidarności 4 • tel. +48 83 342 10 91 • bok@vikking.eu

vikking.eu

